

GENERAL DESCRIPTION

The wireless heat detector samples the environmental temperature in the protected area. An alarm condition is raised when the level of temperature or the thermal variation rate exceeds the alarm threshold.

Picture 1

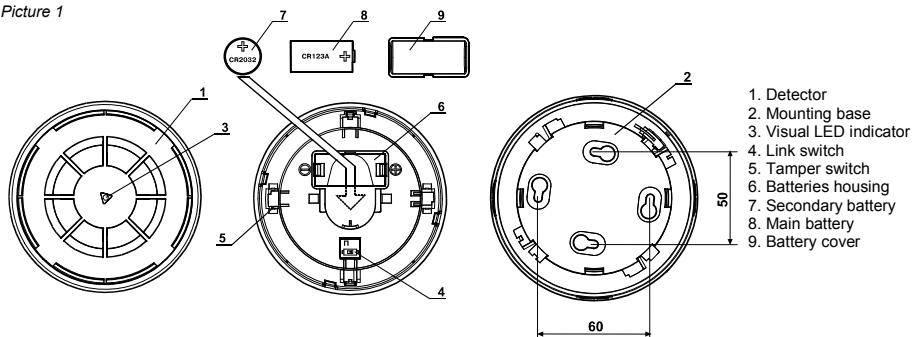

DETECTOR VISUAL LED INDICATOR

The wireless heat detector is equipped with a LED that provides visual indication for functional modes, battery faults and other fault types (see table 1).

LINKING THE DEVICE TO THE SYSTEM

This detector must be linked to the fire security system before installation; specifically it must be linked to its translator or expander module as per installation plan. **For more detailed information about wireless linking refer to "Guide to wireless system installation" document (APN-W0001) or refer to your system supplier.**

This manual gives the specific linking procedure applicable only to this detector.

STANDARD LINKING PROCEDURE

When the Wirelex program or the translator module is waiting for this device to be linked, perform the following actions:

- 1) Check that the link switch is on the "ON" position.
- 2) Extract the isolating tab from the back of the detector (picture 2).
Device LED will indicate **"operating mode"**.
- 3) Move the switch in position "1" to start the linking phase.
Device LED will indicate **"linking mode"**.

LED SIGNAL MEANING	LED VISUAL SIGNAL
"Power up mode" . The isolating tab has just been extracted or the main battery has just been inserted.	Green LED blinks; Orange LED on for 2 seconds; Red LED blinks.
"Linking mode" . Linking phase has been started.	Green LED blinks; Red LED blinking 1 second on and 0.1 second off; Green and red LED alternating for 1 second.
"Linking failure mode" .	Red LED continuously on.
"Normal operating mode" .	LED off.
"Alarm mode" .	Red LED blinking: 0.5 second on and 0.5 second off.
Device unpowered.	LED off.
Main battery fault (low charge)	Orange blinking: 0.1 second on and 5 seconds off.
Secondary battery fault (low charge)	Green LED blinking: 0.1 second on and 5 seconds off.
Both batteries fault	Sequential orange-green LED blinking: 0.1 second on and 5 seconds off.
Tamper fault	LED off.
Other fault type	Sequential orange-green LED blinking: 0.5 second each colour.

Table 1

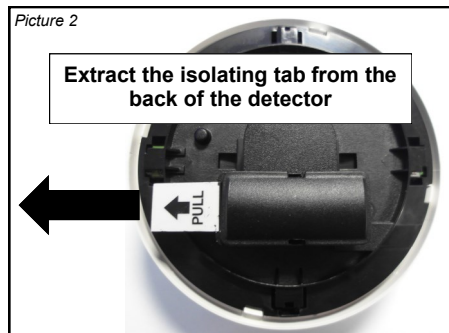

- 4) If linking went ok, the LED will indicate **"normal operating mode"**.
The link switch MUST be left on "1" from now!
- 5) If linking failed, the LED will indicate **"linking failure mode"**; perform the **"RECOVERY LINKING PROCEDURE"**.

RECOVERY LINKING PROCEDURE

- 1) Uninstall the battery housing cover.
- 2) Take out the main battery from its housing.
- 3) Alternate the link switch on "ON" / "1" five times.
- 4) Move the link switch to position "ON".

When the Wirelex program or the translator module is waiting for this device to be linked, perform the following actions:

- 1) Insert the main battery (**Ensure battery's polarity is correct!**).
Device LED will indicate "**operating mode**".
- 2) Move the switch in position "1" to start the linking phase.
Device LED will indicate "**linking mode**".
- 3) If linking went ok, the LED will indicate "**normal operating mode**"; reinstall the battery housing cover.
The link switch MUST be left on "1" from now!
- 4) If linking failed, the LED will indicate "**linking failure mode**"; perform this procedure again.

CHECKING THE WIRELESS LINK QUALITY

It is possible to check wireless link quality between the detector and its linked-to translator or expander module in this way:

- 1) Move the link switch onto the "ON" position.
- 2) Detector's LED indicator will start blinking according to table 2:

LINK QUALITY	EVALUATION	DEVICE'S INDICATION
No connection	Fail	Two red blinks
Link margin is less than 10 dB	Poor	One red blink
Robust communication with link margin from 10 dB to 20 dB	Good	One green blink
Robust communication with link margin over 20 dB	Excellent	Two green blinks

Table 2

- 3) **Move the link switch to position "1" again; device will NOT WORK if the link switch is on position "ON"!**

DETECTOR INSTALLATION

For detector spacing, placement and special applications refer to your specific national standards.

Mount the detector as far as possible from metal objects, metal doors, metal window openings, etc. as well as cable conductors, cables (especially from computers), otherwise the operating distance may greatly drop. The detector must NOT be installed near electronic devices and computer equipment that can interfere with its wireless link quality.

- 1) Choose for the detector a placement position that:
 - a) Complies with your specific standards.
 - b) Is reached by a strong wireless signal from its linked-to translator or expander module.
 - c) Is not interfered by environmental factors (as per note above).
- 2) Install and fix the base, in the selected position, with the screws provided (picture 3).
- 3) Install the detector onto the base (picture 3).
- 4) Carry out a test of the device to meet local regulations (see TESTING).
- 5) If the detector fails the test:
 - Clean it if dirty (see MAINTENANCE - CLEANING).
 - Change batteries if low battery is indicated on the translator (see MAINTENANCE - BATTERY CHANGING).
- 6) Test the detector again (see TESTING).
- 7) If the detector fails the test again replace it (see WARRANTY).

 From the moment you switch on "1" to the moment linking comes to an end, the detector must be only a few inches away from the translator or expander you are linking to.

 Dust covers DO NOT provide complete protection against contamination: detectors should be removed before construction, major re-decoration or other dust producing work is started.

Dust covers MUST be removed before the system can be made operational.



Picture 3

DETECTOR BLOCK

To lock the detector to the base:

- 1) Cut off the small plastic lug on the plastic blocking grip on the detector base (picture 4).
- 2) Install the detector onto the base.
- 3) Check if the detector is effectively locked!

To unlock the detector from the base:

- 1) Insert the tip of a small screwdriver into the side hole of the supporting base (picture 5).
- 2) Push and keep down, with the tip of the screwdriver, the blocking grip on the base.
- 3) Uninstall the detector from the base.

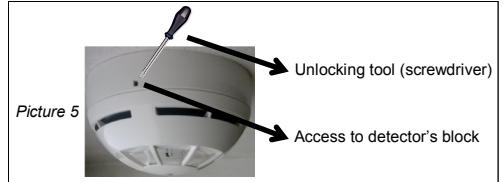
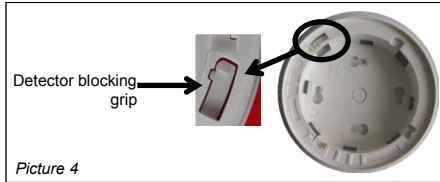

TAMPER DETECTION CAPABILITY

The wireless heat detector is provided with a tamper switch: in case of removal of the detector from its base, a tamper detection message is sent to the control panel.

TESTING

All detectors must be tested after installation and, successively, on a periodic basis.

After each test reset the fire security system from the control panel, as per your control panel instructions.

TEST 1 - MAGNET TEST

Purpose: checking the alarm capability of the detector by using the built-in test circuitry; no alarming agent (heat) is used.

- 1) Hold a suitable magnet in correspondence of the indicated area (picture 6).
- 2) Wait a few seconds.
- 3) If it works, the detector will switch into "**Alarm mode**" (as indicated by the LED indicator).

TEST 2 - HEAT TEST

Purpose: checking the alarm capability of the detector by using heat.

Use suitable heat test devices from approved manufacturers.

- 1) By following its specific instructions, apply the heat test device to the detector.
- 2) Wait a few seconds.
- 3) If it works, the detector will switch into "**Alarm mode**" (as indicated by the LED indicator).

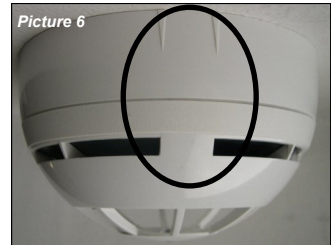

MAINTENANCE - CLEANING

- 1) Remove the detector from its base.
- 2) Thermistor area: use a small, soft bristle brush to dislodge any obvious contaminants such as insects, spider webs, hairs, etc.
- 3) Thermistor area: use a small vacuum tube or dry, clean, compressed air to suck up or blow any remaining small particles away.
- 4) Wipe the exterior housing of the detector with a clean, damp, lint-free cloth to remove any surface film that can later attract airborne contaminants.
- 5) Install the detector onto its base again.
- 6) Test the detector.

MAINTENANCE - BATTERY CHANGING

When a low battery condition is indicated, both, main and secondary, batteries must be changed altogether.

During this procedure the linking switch must NOT be touched at all!

- 1) Remove the detector from its base.
- 2) Remove the battery cover.
- 3) Remove the old primary battery.
- 4) Remove carefully the old secondary battery with the aid of the tip of a small screwdriver: damage must not be made to the detector's internal printed circuit board.
- 5) Insert the new **CR2032A** secondary battery. **Positive pole facing up.**
- 6) Insert the new **CR123A** primary battery. **Ensure that battery polarity is correct.**
- 7) Reinstall the battery cover.
- 8) Install the detector onto its base again.
- 9) Test the detector.

Table 3

TECHNICAL SPECIFICATIONS **		
Communication range with the translator or expander	200 m	Open space
Operating frequency	868 MHz	
Modulation type	FSK	
Operating frequency channels	7	
Radiated power	5 dBm (3 mW)	Typical
Transmission message period	60 sec	Default
Alarm threshold temperature	58 °C	
Main battery *	Type CR123A (3 Vdc)	5 years typical
Secondary battery *	Type CR2032A (3 Vdc)	2 months typical
Dimensions	110 mm x 65 mm	Including adaptor wall base
Weight	130 g	Including adaptor wall base
IP rating	40	
Max tolerated humidity (no condensing)	95% RH	
Operating temperature range	From -10 °C to +55 °C	

* When a low battery condition is indicated, both, main and secondary, batteries must be changed altogether.

** Check latest version of document TDS-SG350 for further data, obtainable from your supplier.

WARNINGS AND LIMITATIONS

Our devices use high quality electronic components and plastic materials that are highly resistant to environmental deterioration. However, after 10 years of continuous operation, it is advisable to replace the devices in order to minimize the risk of reduced performance caused by external factors. Ensure that this device is only used with compatible control panels. Detection systems must be checked, serviced and maintained on a regular basis to confirm correct operation. Smoke sensors may respond differently to various kinds of smoke particles, thus application advice should be sought for special risks. Sensors cannot respond correctly if barriers exist between them and the fire location and may be affected by special environmental conditions. Refer to and follow national codes of practice and other internationally recognized fire engineering standards. Appropriate risk assessment should be carried out initially to determine correct design criteria and updated periodically.

WARRANTY

All devices are supplied with the benefit of a limited 3 year warranty relating to faulty materials or manufacturing defects, effective from the production date indicated on each product. This warranty is invalidated by mechanical or electrical damage caused in the field by incorrect handling or usage. Product must be returned via your authorized supplier for repair or replacement together with full information on any problem identified. Full details on our warranty and product's returns policy can be obtained upon request.

The warranty does not cover the provided batteries.



0832

ARGUS SECURITY S.R.L.
Via del Carneto, 14
34015 Muggia (TS)
Italy

10

SG0110CPR20130901

EN 54-25:2008

EN 54-5:2000+A1:2002

SG350

For use in compatible fire
detection and alarm system

Class A1R